



NEPTUNE X-ECO FULL INVERTER HEAT PUMP



INSTALLATION GUIDE AND USER MANUAL

THANK YOU FOR PURCHASING A NEPTUNE FULL INVERTER HEAT PUMP.
Please read the manual thoroughly before installing or using the product.
Only qualified technicians must install the product. Keep this manual for future reference.

TABLE OF CONTENTS

	Page
SECTION 1: IMPORTANT WARNINGS AND SAFETY INFORMATION	4-5
SECTION 2: TRANSPORT, STORAGE AND HANDLING	5
SECTION 3: PACKAGING CONTENTS	5
SECTION 4: PRODUCT SPECIFICATIONS	6-8
4.1: PRODUCT DIMENSIONS	6
4.2: TECHNICAL DATA	7-8
4.3: OPERATING CONDITIONS	8
SECTION 5: INSTALLATION	8-18
5.1: IMPORTANT INSTALLATION INFORMATION	8
5.2: POSITIONING AND LOCATION OF HEAT PUMP	9
5.3: INSTALLATION OF THE HEAT PUMP	9-11
5.4: FLOW VALVE POSITIONS	12
5.5: WIRING OF THE HEAT PUMP	12-13
5.6: WIRING DIAGRAM: SINGLE PHASE 230V 50Hz	13
5.7: WIRING DIAGRAM FOR EXTREME WINTER CONDITIONS: SINGLE PHASE 230V ≤500W	14
5.8: WIRING DIAGRAM FOR EXTREME WINTER CONDITIONS: SINGLE PHASE 230V >500W	15
5.9: PARALLEL CONNECTION WITH FILTRATION CLOCK	16
5.10: CONNECTING THE NEPTUNE HEAT PUMP CONTROLLER	16-18
SECTION 6: INITIAL START-UP	19
6.1: PRE-STARTUP INSPECTION	19
6.2: INITIAL STARTUP	19
SECTION 7: OPERATING INSTRUCTIONS	20-23
7.1: IMPORTANT OPERATING INFORMATION	20
7.2: HEAT PUMP TOUCHPAD OVERVIEW	20-21
7.3: TURNING ON THE HEAT PUMP	22
7.4: SETTING THE TEMPERATURE	22
7.5: SETTING THE HEATING/COOLING MODE	22
7.6: SETTING THE OPERATING MODE (SMART/SILENCE MODE)	22
7.7: CHANGING TEMPERATURE BETWEEN °C AND °F	23
7.8: DEFROSTING	23
SECTION 8: WIFI SETUP	23-28
8.1: APP DOWNLOAD AND ACCOUNT REGISTRATION	23
8.2: PAIRING YOUR DEVICE WITH THE HEAT PUMP VIA AUTO-DISCOVERY/BLUETOOTH	24
8.3: PAIRING YOUR DEVICE WITH THE HEAT PUMP VIA MANUALLY ADDING	25
8.4: PAIRING YOUR DEVICE WITH THE HEAT PUMP VIA AP MODE	26
8.5: RE-PAIRING YOUR DEVICE	27
8.6: APP FEATURES	27
8.7: SHARE DEVICES WITH FAMILY MEMBERS	28
8.8: CREATE A FAMILY	28
SECTION 9: MAINTENANCE	29
9.1: REGULAR MAINTENANCE	29
9.2: ANNUAL MAINTENANCE – QUALIFIED TECHNICIAN ONLY	29
SECTION 10: WINTERISING	29-30
SECTION 11: TROUBLESHOOTING	30-31
SECTION 12: SCHEMATICS – NHE07, NHE09, NHE13, NHE17, NHE21	32-34
SECTION 13: WARRANTY & PRODUCT REGISTRATION	35

SECTION 1: IMPORTANT WARNINGS AND SAFETY INFORMATION



This manual contains important information about the installation, operation, and safe use of this product. This information should be given to the owner and/or operator of the heat pump. When installing and using the heat pump, basic safety precautions should always be followed. Failure to follow safety warnings and instructions in this manual can result in serious injury and/or damage to your equipment. Read and follow all warning notices and instructions which are included in this manual.



This Full Inverter Heat Pump contains R32 refrigerant gas which is a flammable substance under certain conditions.

GENERAL WARNINGS

- Read the instructions before installing and using the heat pump.
- Failure to follow these instructions and comply with all applicable codes may cause serious bodily injury and/or property damage and will void the warranty.
- Installers/operators must follow manufacturer's instructions and keep in compliance with national or local standards for installation. Under no circumstances will the manufacturer be held responsible for any outcome incurred by failure to comply with applicable standards or local regulations.
- Turn off the power during thunderstorms and severe weather.
- Do not use or store combustible gas or liquid such as thinners, paint or fuel near the heat pump.
- Always keep the heat pump in the upright position especially when storing or moving the heat pump.
- The heat pump is designed for heating swimming pools; do not use it for any other purpose.
- The surroundings of the heat pump must be kept clear to avoid restricting ventilation.
- The heat pump must be kept away from any source of fire.
- Do not put anything into the inlet or outlet, and do not remove the fan cover.
- This product contains electrical equipment. Dispose of the product in accordance with local regulations.

INSTALLATION, SERVICE AND MAINTENANCE WARNINGS

- **Always use a qualified electrician to perform any electrical work. A licenced electrician must read these instructions before installing.**
- Gas leakage tests must be done before and after installation.
- Installation, removal, service and gas disposal/refill of the heat pump must be handled by qualified professionals. Repairs should be carried out in a well ventilated area.
- The heat pump must be positioned on a concrete base.
- The frame must be secured using M10 bolts. Frame/brackets must be of a suitable strength and anti-rust treated.
- Do not lift the heat pump using the water unions.
- The heat pump must be installed in a well ventilated, outside area.
- Ensure power is disconnected during installation or service.
- Stop installation if there is any gas leakage. The unit must be returned to the authorised dealer.
- Vacuum completely before welding. Field welding is not allowed.
- Always comply with the national and local electrical codes and standards.
- Ensure electrical cable size is adequate for heater requirements at the installation location.
- Earth/ground the heat pump to protect yourself against short circuits inside the unit.
- Check that there is adequate voltage and current available at the heater connection to run the unit. Voltage ranges outside of the required parameters will damage the heat pump and void the warranty.
- Ensure the power cable and circuit breaker are of suitable size for the heat pump being installed.
- To ensure heating efficiency, the water pipe length should be 10m or less between the pool and the heat pump.
- Hard/rigid plumbing must be used for the inlet and outlet water unions.
- The heat pump must be maintained/serviced by a qualified professional.
- The main power switch should be out of the reach of children.
- Use only genuine replacement parts supplied by the manufacturer for service and repair.
- Do not try to repair the heat pump yourself or open the casing. In case of malfunction, switch off the main power immediately and contact your authorised dealer.

DISCLAIMER

Information in this manual is intended to provide general information on a particular subject(s) in good faith and is not an exhaustive treatment of such subject(s). Its use is beyond the control of the author, contributor, publishers, and distributors and should not be relied upon without consulting your local Professional for comprehensive advice. This manual includes subject(s) that should only be performed by or under the direction and advice of your local Professional and under no circumstances should the manual be used as a substitute for such professionals. No representations or warranties are made that the content, advice, and recommendations in this manual are current, free from errors or omissions, or appropriate for the user's circumstances or abilities. No liability is accepted for any loss suffered as a result of any user's reliance on such content. All information in this document is subject to change at any time without notice.

SECTION 2: TRANSPORT, STORAGE AND HANDLING

- Sealing is not allowed during transportation.
- Transporting goods at a constant speed is needed to avoid sudden acceleration or sudden braking, so as to reduce the collision of goods.
- The unit must be kept away from any source of fire.
- The heat pump must be stored in a bright, wide and open space with adequate ventilation.
- Do not lift the heat pump using the water unions.
- Do not use or store combustible gas or liquid such as thinners, paint and fuel near the heat pump.
- Always keep the heat pump in the upright position especially when storing or moving the heat pump.

SECTION 3: PACKAGING CONTENTS

The following items are included in the packaging of the heat pump. Please contact your authorised dealer if any items are damaged or missing.

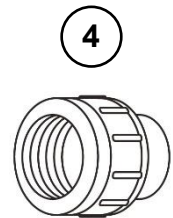
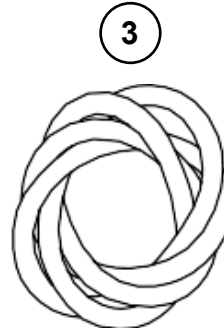
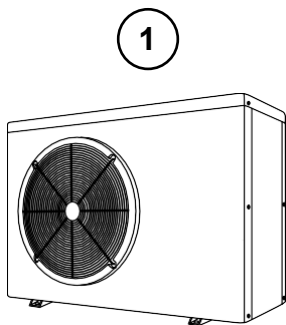

(1) Heat Pump x 1

(2) Drain Plug x 1

(3) Drain Hose x 1

(4) Unions x 2

(5) Rubber Foot x 4

(6) Bolt Assembly x 4

(7) User Manual x 1

(8) PVC Pipe Sticker Sheet x 1

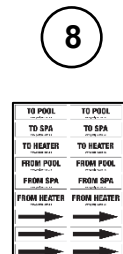
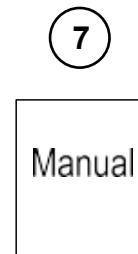
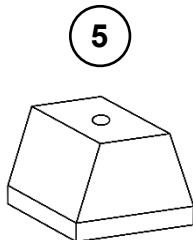

SECTION 4: PRODUCT SPECIFICATIONS

4.1: PRODUCT DIMENSIONS

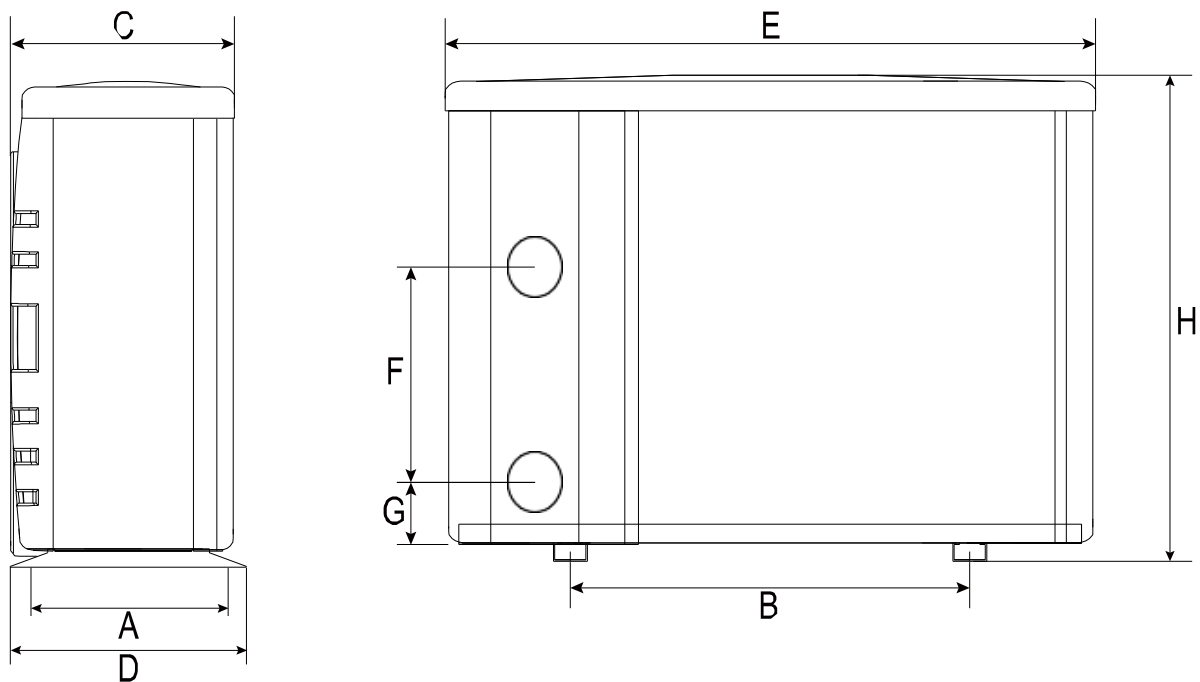

	UNITS (mm)	A	B	C	D	E	F	G	H
MODEL	NHE07	324	560	330	349	872	310	74	654
	NHE09	324	560	330	349	872	250	74	654
	NHE13	324	560	330	349	872	320	74	654
	NHE17	324	590	330	349	962	350	74	654
	NHE21	324	590	325	349	962	350	74	754
NOTE: This data is subject to change without notice.									

4.2: TECHNICAL DATA

Model	NHE07	NHE09	NHE13	NHE17	NHE21
Advised pool volume (L)	15,000 – 30,000	20,000 – 35,000	30,000 – 50,000	35,000 – 65,000	45,000 – 80,000
Working air temp (°C)	0 – 43				
Performance Condition: Air 26°C, Water 26°C, Humidity 80%					
Heating capacity (kW)	7.0	9.0	12.5	16.0	20.0
C.O.P	10.3 – 6.6	10.6 – 6.8	11.6 – 7.0	11.2 – 7.1	11.8 – 6.5
C.O.P at 50% capacity	9.3	9.6	10.1	9.7	10.2
Performance Condition: Air 15°C, Water 26°C, Humidity 70%					
Heating capacity (kW)	5.0	6.3	8.5	11.0	14.0
C.O.P	6.0 – 4.8	6.1 – 4.5	6.3 – 4.8	6.4 – 4.7	6.5 – 4.6
C.O.P at 50% capacity	5.8	5.7	6.1	5.9	6.1
Performance Condition: Air 35°C, Water 28°C, Humidity 80%					
Cooling capacity (kW)	2.5	3.1	4.6	5.6	7.8
Sound level at 1m dB(A)	38.8 – 50.2	40.6 – 52.5	42.9 – 53.0	45.2 – 56.3	45.3 – 57.1
Sound level of 50% capacity at 1m dB(A)	42.8	45.8	48.5	48.7	49.6
Sound level at 10m dB(A)	18.8 – 30.2	20.6 – 32.5	22.9 – 33.0	25.2 – 36.3	25.3 – 37.1
Power supply	10A Plug		15A Plug	230V / 1 Ph / 50Hz	
Rated input power (kW) at air temperature 15°C	0.29 – 1.04	0.36 – 1.40	0.47 – 1.78	0.59 – 2.34	0.75 – 3.04
Rated input current (A) at air temperature 15°C	1.26 – 4.52	1.57 – 6.09	2.02 – 7.74	2.52 – 10.17	3.26 – 13.21
Max input current (A)	6.5	8.0	12.5	17.0	19.5
PVC pipe required (mm)	40				
Pool pump water flow (L/min)	33 - 67	50 - 67	67 - 100	108 – 142	133 - 167
Pool pump max. head (m)	10				
Net Dimension LxWxH (mm)	872x349x654	872x349x654	872x349x654	962x349x654	962x349x754
Net Weight (kg)	42	46	49	60	68

The values indicated are valid under ideal conditions: pool covered with an isothermal cover, filtration system running at least 15 hours a day. Related parameters subject to adjustment periodically for technical improvement without further notice. For details please refer to nameplate.

MODEL		NHE07	NHE09	NHE13	NHE17	NHE21
Breaker	Rated Current (A)	8.0	9.5	15.0	20.5	23.5
	Rated Residual Action Current (mA)	30	30	30	30	30
Max input current(A)		6.5	8.0	12.5	17.0	19.5
Power Supply		230V 50Hz	230V 50Hz	230V 50Hz	230V 50Hz	230V 50Hz
Fuse (A)		8.0	9.5	15.0	20.5	23.5
Power Cord (mm ²)		3x1.5	3x1.5	3x2.5	3x4	3x6
Signal cable (mm ²)		3x0.5	3x0.5	3x0.5	3x0.5	3x0.5

4.3: OPERATING CONDITIONS

ITEMS		RANGE
Operating Range	Ambient Air Temperature*	0°C – 43°C
Temperature Setting	Heating	18°C – 40°C
	Cooling	12°C – 30°C

*Ideal ambient air temperature is 15°C – 25°C.

SECTION 5: INSTALLATION

5.1: IMPORTANT INSTALLATION INFORMATION

- **Always use a qualified electrician to perform any electrical work. A licenced electrician must read these instructions before installing.**
- The heat pump must be installed in a well ventilated, outside area with sufficient space for installation and maintenance.
- Gas leakage tests must be done before and after installation.
- The heat pump must be positioned on a concrete base.
- The frame must be secured using M10 bolts. Frame/brackets must be of a suitable strength and anti-rust treated.
- Do not lift the heat pump using the water unions.
- Ensure power is disconnected during installation or service.
- Installation must be stopped if there is any gas leakage, and the unit must be returned to the authorised dealer.
- Vacuum completely before welding. Field welding is not allowed.
- Always comply with the national and local electrical codes and standards.
- Ensure electrical cable size is adequate for heater requirements at the installation location.
- A licenced electrician must read these instructions before installing.
- Earth/ground the heat pump to protect yourself against short circuits inside the unit.
- Check that there is adequate voltage and current available at the heater connection to run the unit. Voltage ranges outside of the required parameters will damage the heat pump and void the warranty.
- Ensure the power cable and circuit breaker are of suitable size for the heat pump being installed.
- To ensure heating efficiency, the water pipe length should be 10m or less between the pool and the heat pump.
- The inlet and outlet water unions cannot bear the weight of soft/flexible plumbing. Hard/rigid plumbing must be used.
- The main power switch should be out of the reach of children.



5.2: POSITIONING AND LOCATION OF HEAT PUMP

The heat pump must be installed in accordance with the following diagrams. Distances in the diagram are the minimum distance allowed. The heat pump must be positioned on solid level ground (concrete slab) outdoors in a place with good ventilation. Do not install the heat pump in an enclosed area. Ensure there is sufficient access space for installation and maintenance.

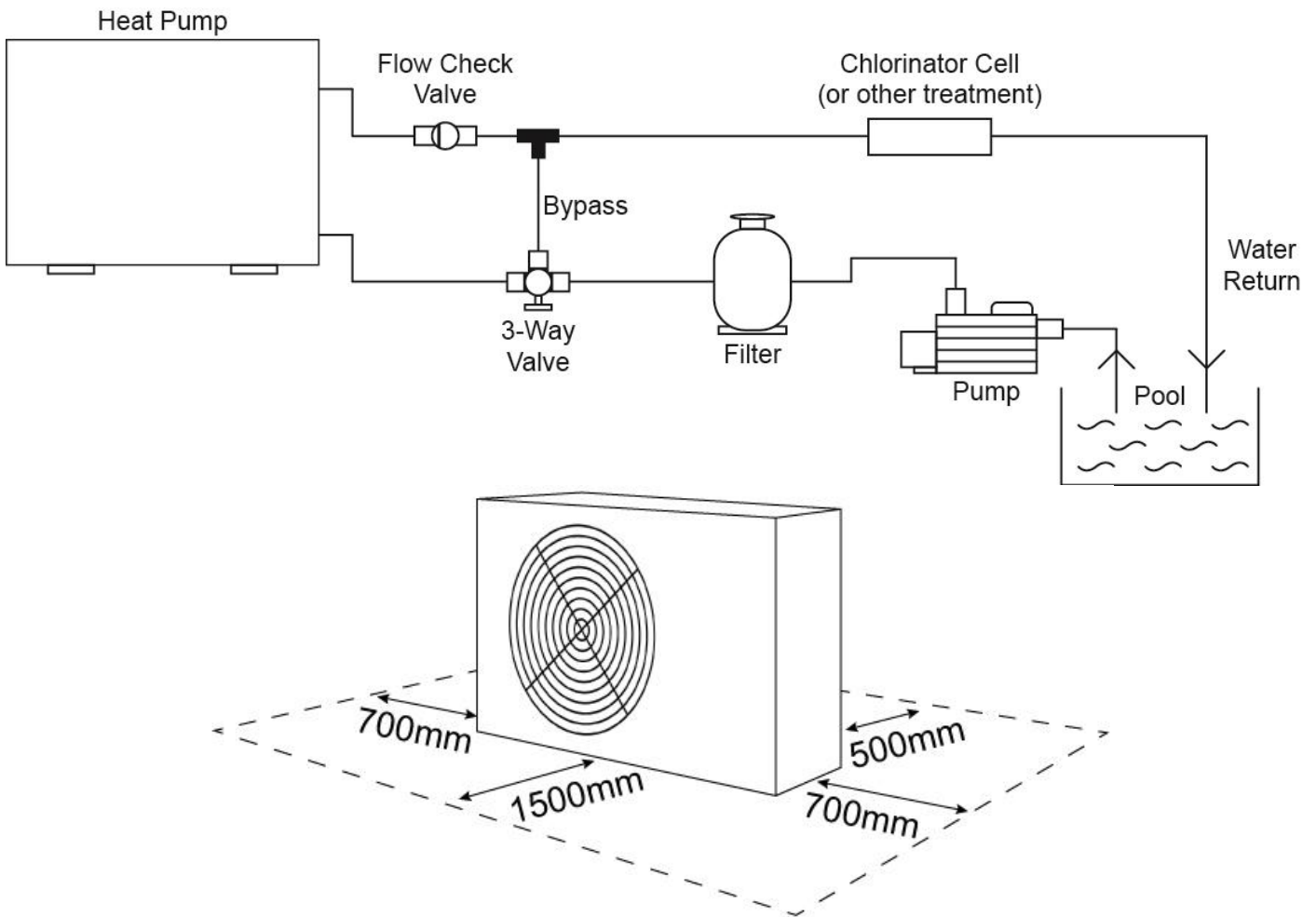

5.3: INSTALLATION OF THE HEAT PUMP

1. Install the 4 rubber feet onto the heat pump's legs, using the supplied bolts.

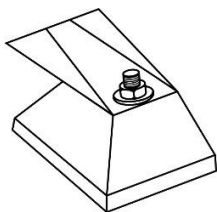

2. Install the drain plug into the drain hose, then attach the drain plug to the drain hole underneath the heat pump.

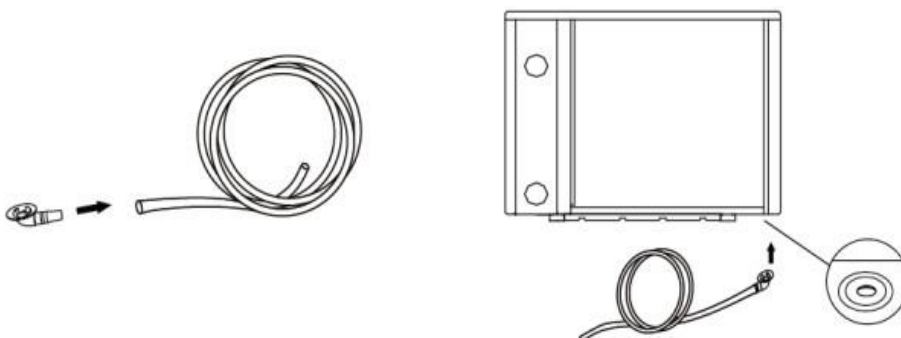

3. Run the drain hose downhill to a suitable location, for example a garden or nearby stormwater drain. When the heat pump is running, there will be condensation water discharged from the drain hose.
4. Ensure the heat pump is equipped with a circuit breaker and electrical isolator switch.
5. The heat pump requires a pool pump (supplied by the user). Refer to the Specifications Table in Section 4.2 for recommended pump water flow and maximum head information for the model being installed.
6. Install the unions as follows:

STEP 1

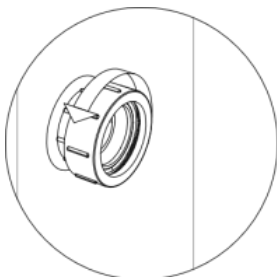

STEP 2

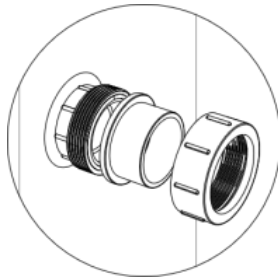

STEP 3

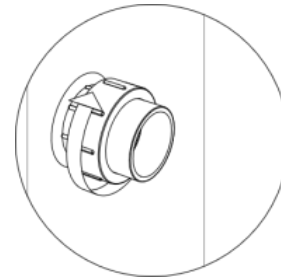

7. Connect the inlet downstream, after the pool pump and filter.

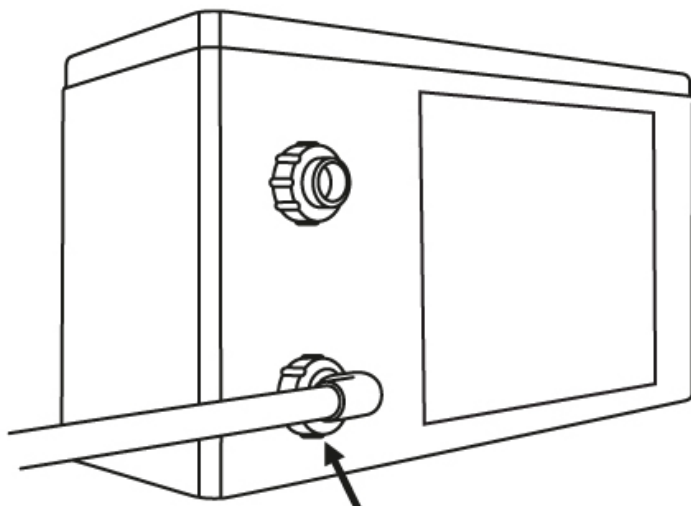

8. Connect the outlet upstream before chlorinator, acid injection or other chemical dosing systems.

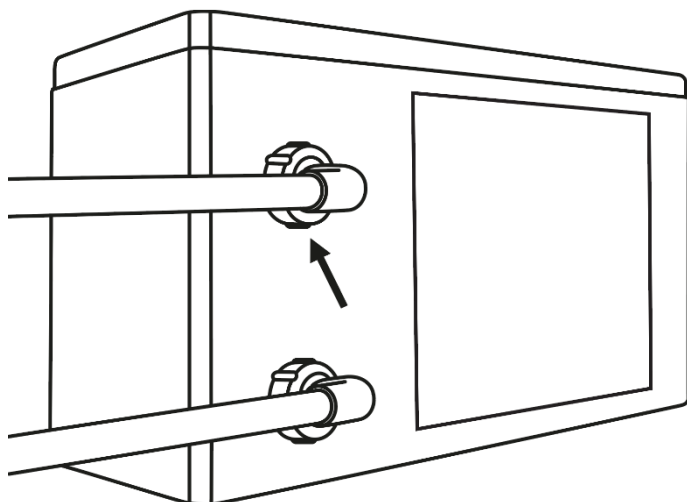

9. Create a flow bypass between the inlet and outlet pipework.

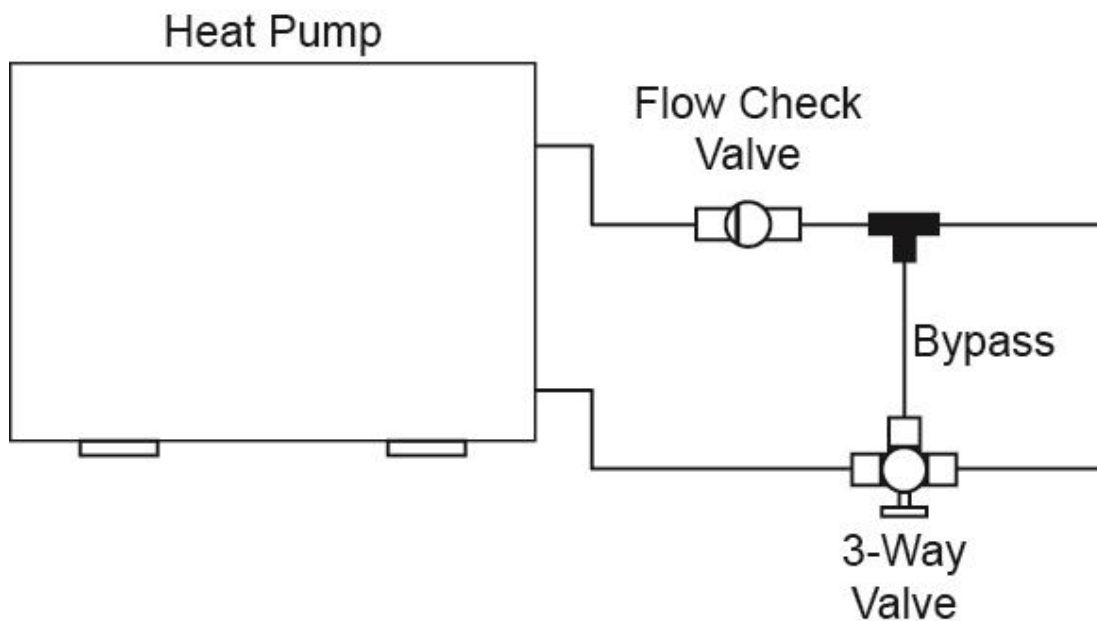

5.4: FLOW VALVE POSITIONS

5.4.1:

100% FULL FLOW TO HEAT PUMP
AND RETURN TO POOL

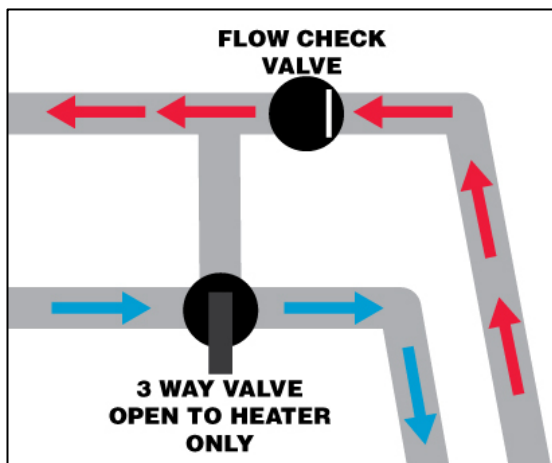

5.4.2:

NO FLOW THROUGH HEAT PUMP
Used to bypass heat pump, during heavy chemical
dosing and maintenance/service of heat pump.

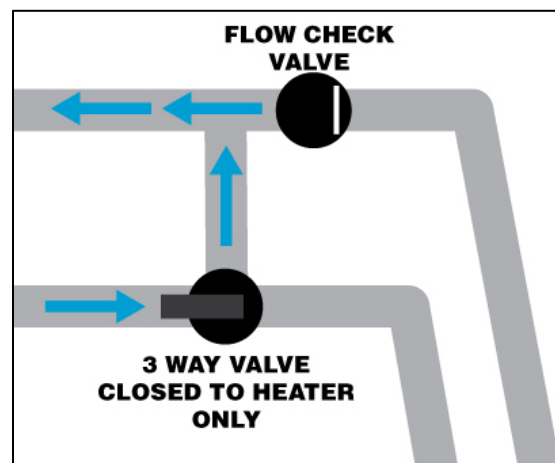

5.4.3:

RESTRICTED WATER FLOW TO HEAT PUMP
Used to reach the temperature differential
between the inlet and outlet.

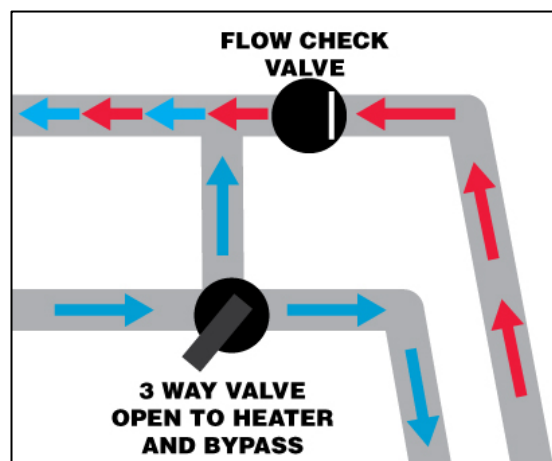

5.5: WIRING OF THE HEAT PUMP

1. Always use a qualified electrician to perform any electrical work. A licenced electrician must read these instructions before installing.
2. Wiring must be connected by a qualified professional electrician, according to the details set out in this manual.
3. The heat pump must be hard wired.
4. Ensure power is disconnected during installation or service. Always comply with the national and local electrical codes and standards. Ensure electrical cable size is adequate for heater requirements at the installation location.
5. The layout of power and signal cables should be neat and orderly. Considering environmental conditions (ambient temperature, direct sunlight, rain, grid voltage, cable length etc), the cross-sectional area of the cable can be appropriately increased.
6. Set breaker or fuse according to the below table.

7. Check that there is adequate voltage and current available at the heater connection to run the unit. Refer to the below table. Voltage ranges outside these parameters will damage the heat pump.

MODEL		NHE07	NHE09	NHE13	NHE17	NHE21
Breaker	Rated Current (A)	8.0	9.5	15.0	20.5	23.5
	Rated Residual Action Current (mA)	30	30	30	30	30
Max input current(A)		6.5	8.0	12.5	17.0	19.5
Power Supply		230V 50Hz	230V 50Hz	230V 50Hz	230V 50Hz	230V 50Hz
Fuse (A)		8.0	9.5	15.0	20.5	23.5
Power Cord (mm ²)		3x1.5	3x1.5	3x2.5	3x4	3x6
Signal cable (mm ²)		3x0.5	3x0.5	3x0.5	3x0.5	3x0.5

NOTE: The above data is adapted to a power cord length of ≤ 10m. If power cord is > 10m, wire diameter must be increased. The signal cable can be extended to 50m maximum.

8. Connect the power wiring according to the following information:

Use a Philips Head screwdriver to remove 2 screws from the terminal box cover, and then 2 screws from the terminal block cover.

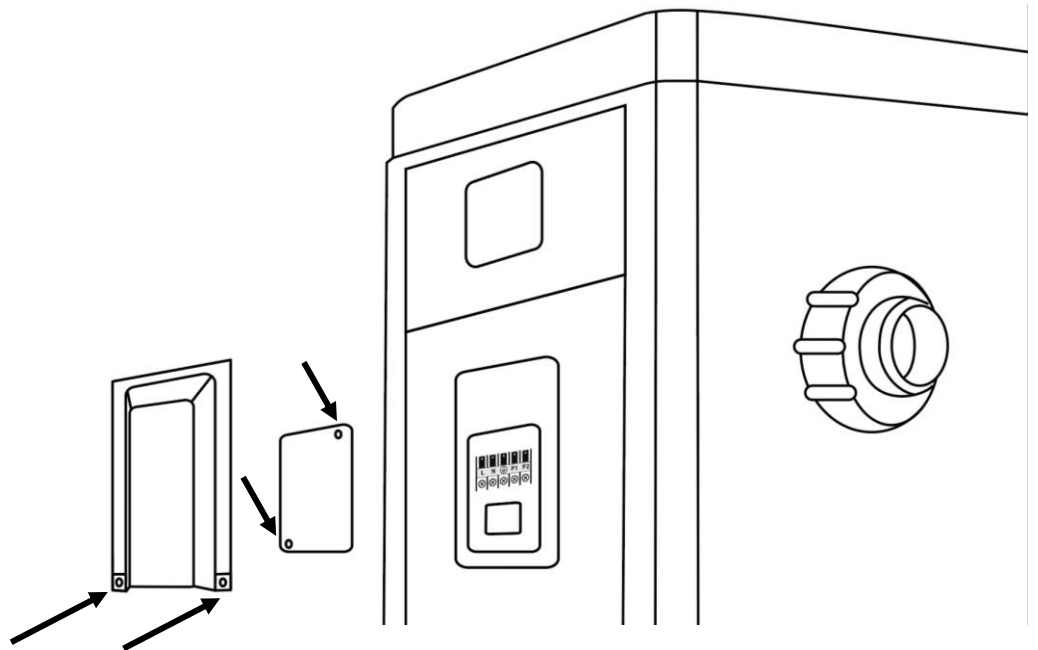

5.6: WIRING DIAGRAM: SINGLE PHASE 230V 50Hz

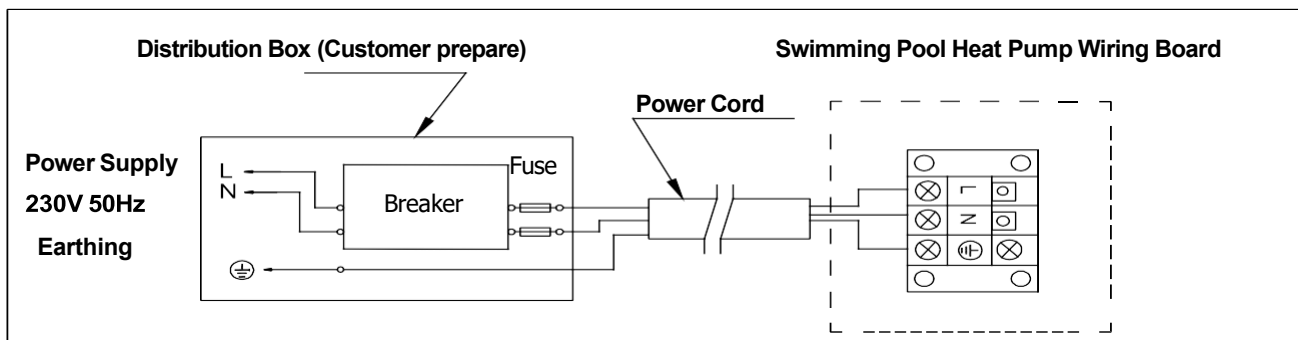

5.7: WIRING DIAGRAM FOR EXTREME WINTER CONDITIONS: SINGLE PHASE 230V ≤500W

Use this wiring diagram when installing a **SINGLE PHASE 230V ≤500W** heat pump in a location with extreme winter conditions (water freezing in pipes).

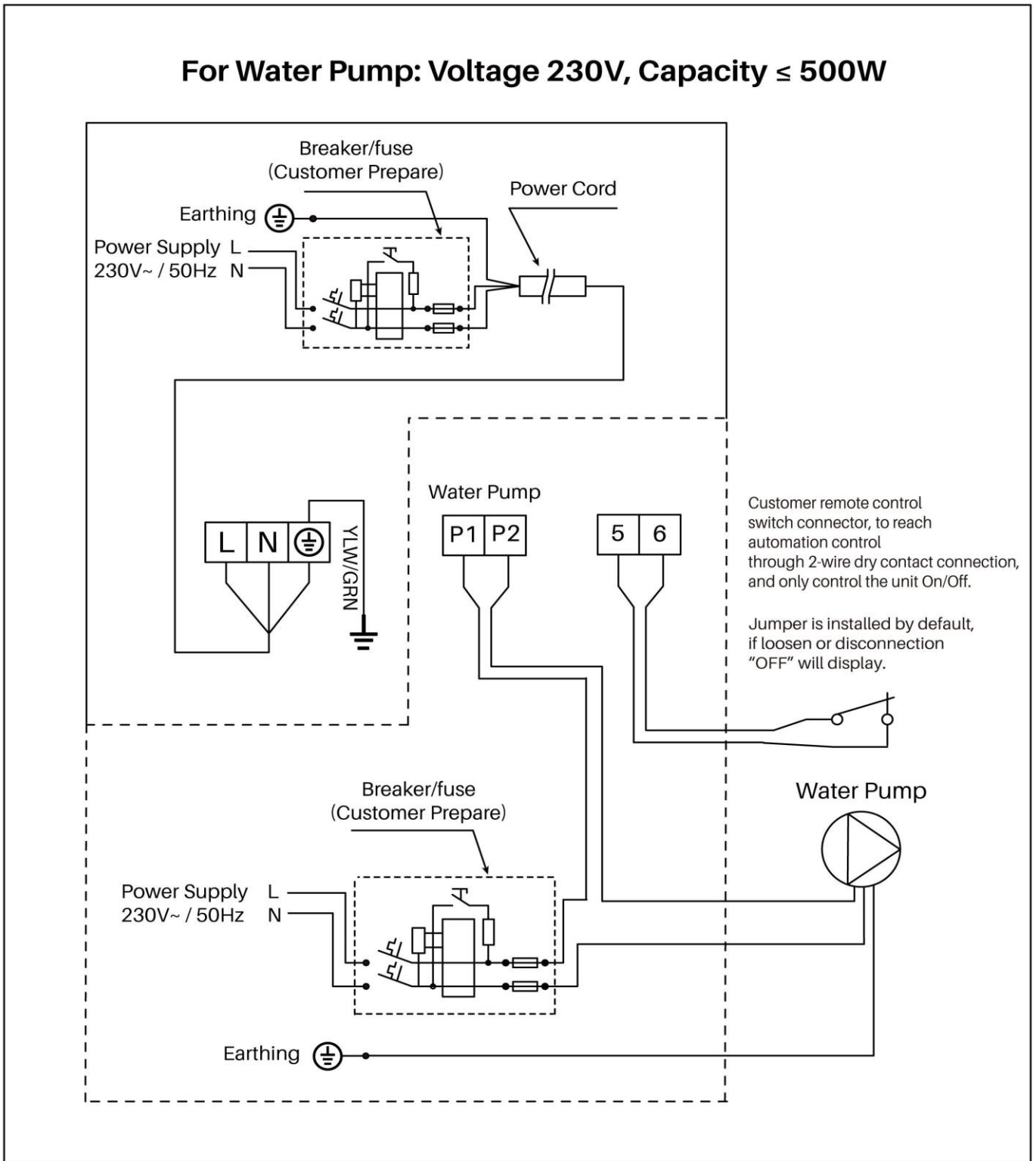

5.8: WIRING DIAGRAM FOR EXTREME WINTER CONDITIONS: SINGLE PHASE 230V >500W

Use this wiring diagram when installing a **SINGLE PHASE 230V >500W** heat pump in a location with extreme winter conditions (water freezing in pipes).

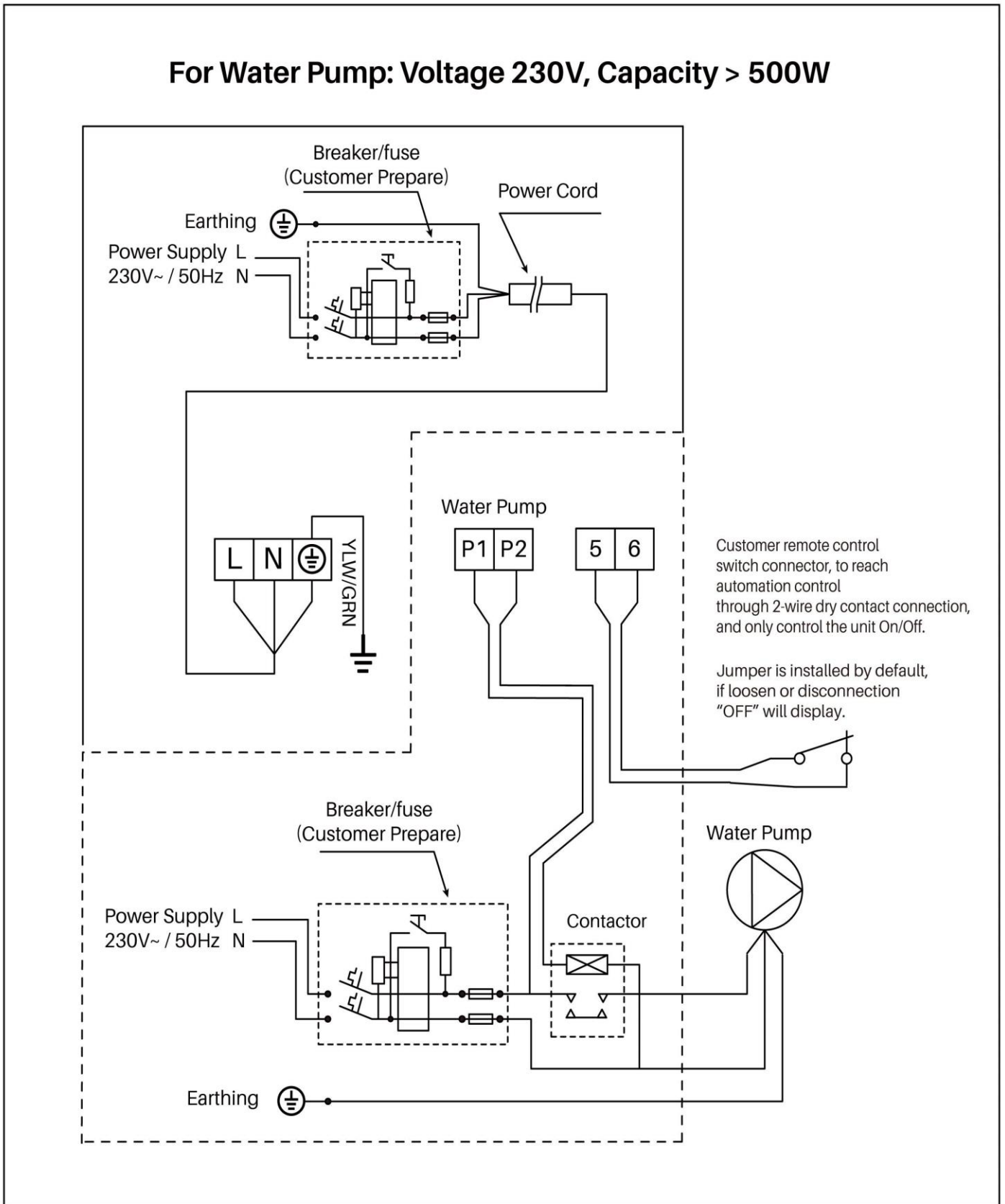

5.9: PARALLEL CONNECTION WITH FILTRATION CLOCK

A: Water pump timer

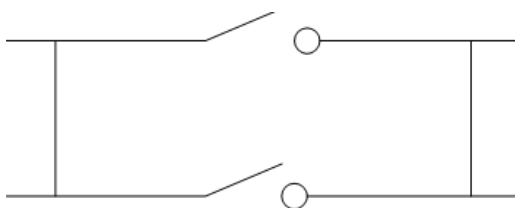

B: Water pump wiring of Heat Pump

Note: The installer should connect A parallel with B (as above picture). To start the water pump, condition A or B should be connected. To stop the water pump, both A and B should be disconnected.

5.10: CONNECTING THE NEPTUNE HEAT PUMP CONTROLLER

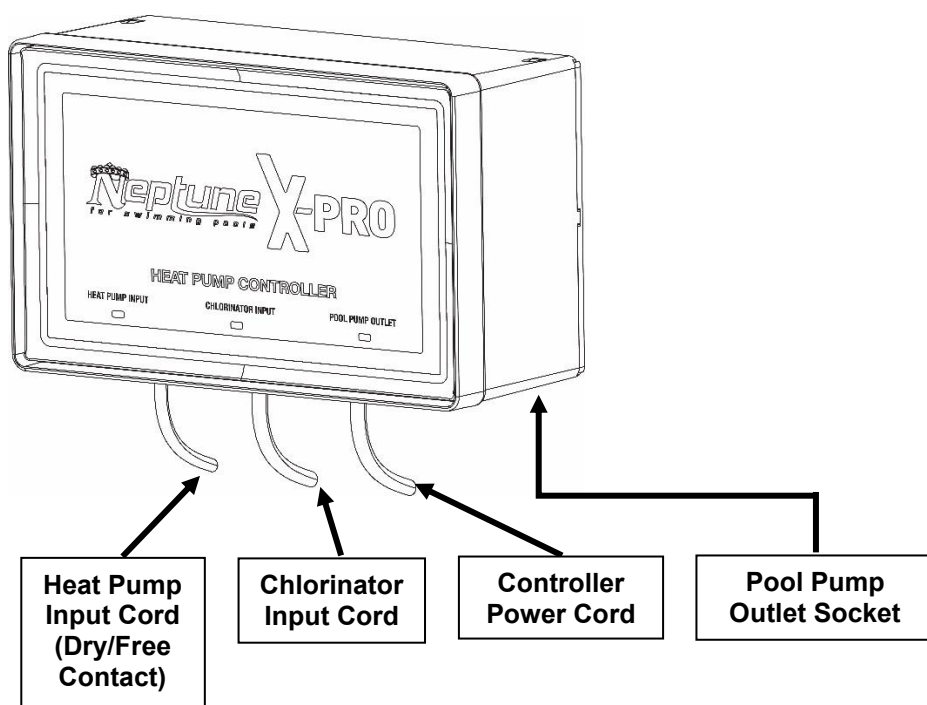

Heat Pump Input Cord: Connect this 2-pin terminal cable into the potential free dry contact on the Heat Pump (the P1 and P2 terminals located in the Electrical Box). This is a signal from the heat pump to turn the pool pump on. **See Pages 17 - 18 for instructions on how to access the Electrical Box.**

Chlorinator Input Cord: Fit this plug to the AC Socket outlet on the Chlorinator.

Controller Power Cord: Connect the Controller's power cord to a wall power socket. Don't forget to also plug your Chlorinator into a wall power socket.

Pool Pump Outlet Socket: Plug the power cord from the pool pump into this AC Socket underneath the controller.

***For full installation instructions of this controller, refer to the Neptune Heat Pump Controller User Manual.

***For other branded controllers please refer to their respective manuals. Most controllers will still connect to P1 and P2 terminals in the heat pump's Electrical Box.

1. Use a Philips Head screwdriver to remove 2 screws from the terminal box cover, and then 2 screws from the terminal block cover.

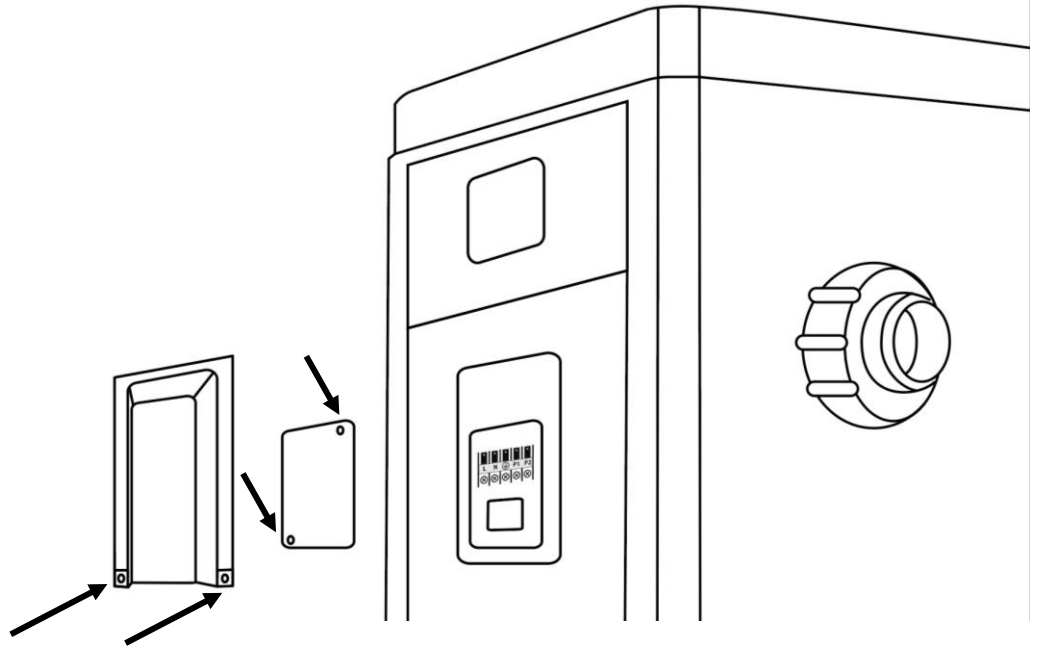



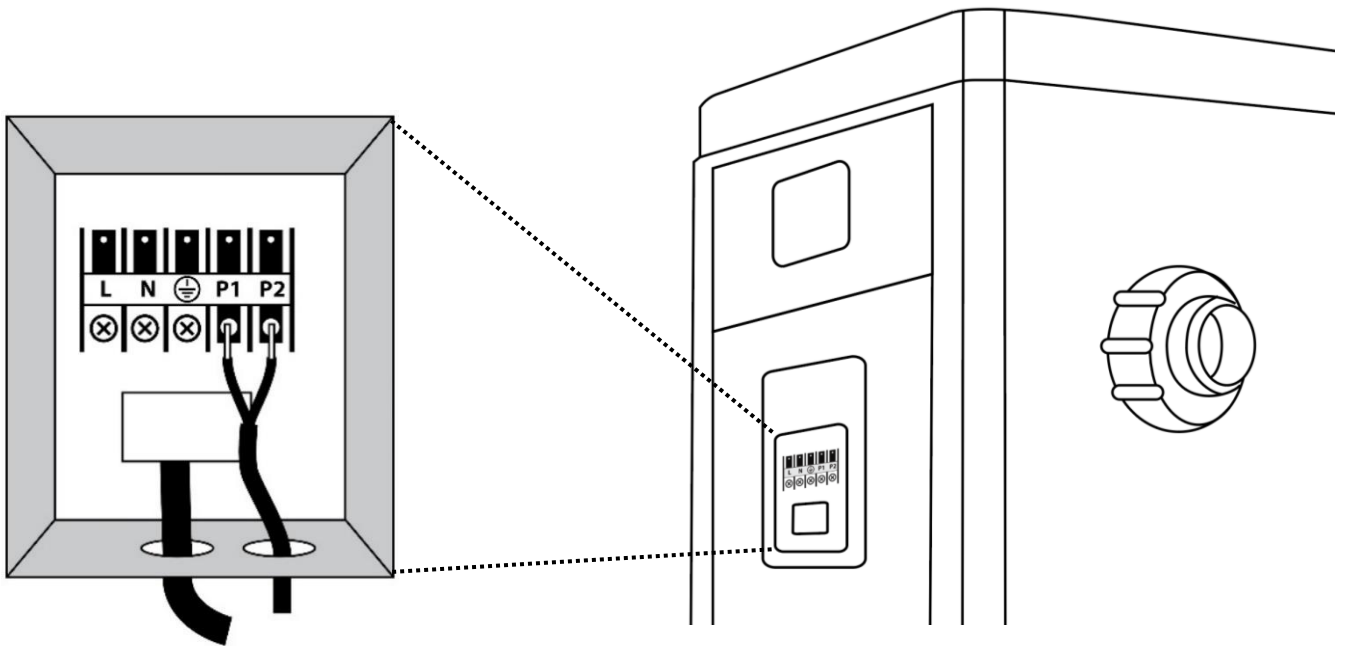

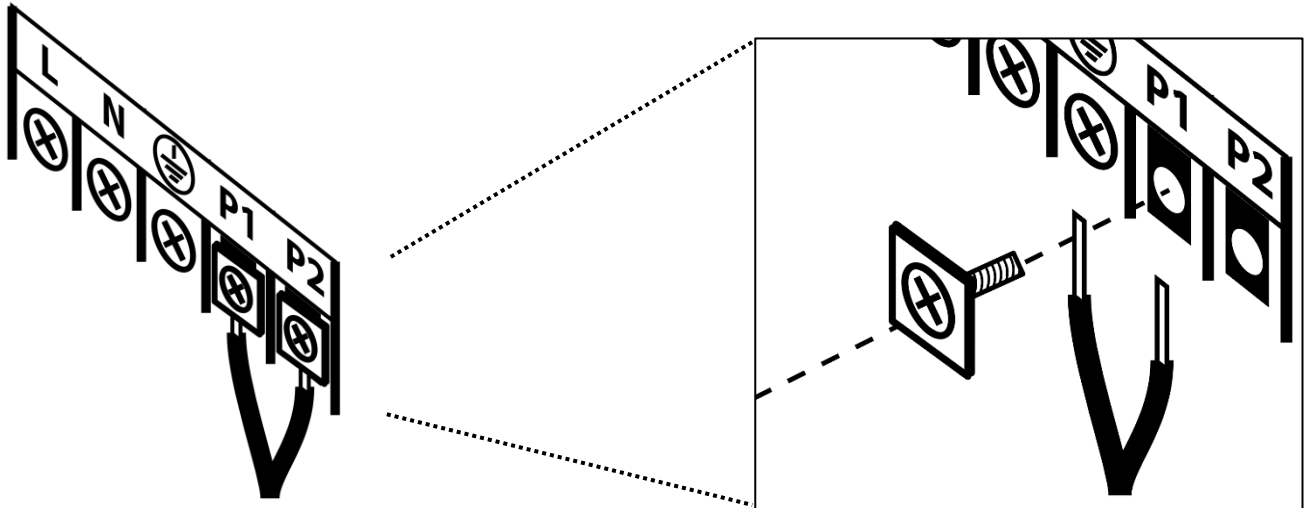

2. Thread the Neptune Heat Pump Controller's 2-pin cable up into the Electrical Box.



- Screw the Heat Pump Controller's 2-pin cable to the P1 and P2 Dry Contact connections inside the Electrical Box. Ensure the 2-pin cable wires are sandwiched between the screw plate and the contact plate.



- Re-attach all covers and panels.
- In order for the Heat Pump Controller to function, some settings in the heat pump are required to be changed. Changing these settings requires you to turn on the heat pump. Before turning on the heat pump, please run through all instructions in **Section 6: Initial Start-Up**, then return to the following steps.
- After following the initial start-up instructions in Section 6, ensure the heat pump is still on.
- Press  and  together for 5 seconds to enter the "Parameter Checking" status screen. The parameter code "P0" and the parameter value "0" will display on the screen, e.g. "P0 0".
- Press  to enter the "Parameter Modification" mode.
- Press  two times to change the value from 0 to 2, then press  to save your changes.
- Press  to exit "Parameter Checking" status and return to the main screen.

NOTES:

"P0 0" means the heat pump will run the pool pump 24 hours a day.

"P0 2" means the heat pump will run the pool pump through the Heat Pump Controller. The heat pump will turn on for 3 minutes every hour to check the water temperature. If the water temperature is correct, the heat pump will turn off. If the water temperature needs to be adjusted, the heat pump will run until the water temperature is achieved, and then the heat pump, Heat Pump Controller, and pool pump will turn off.

SECTION 6: INITIAL START-UP



Check all wirings carefully before turning on the heat pump.

6.1: PRE-STARTUP INSPECTION

1. Check installation of the entire heat pump and the pipe connections according to the installation instructions in this manual.
2. Check the electrical wiring according to the electrical wiring diagram and earthing connection in this manual.
3. Ensure that the main power is connected properly.
4. Ensure there are no obstacle/blockages in front of the air inlet and outlet of the heat pump.

6.2: INITIAL STARTUP

1. Ensure the 3-Way Valve is fully open, then turn the pool pump on.
2. Check there are no water leaks and verify adequate flow to and from the pool.
3. As the heat pump is hardwired, turn on the isolation switch.
4. Press the Power symbol on the heat pump touchpad.
5. In order to protect the heat pump, the heat pump is equipped with a Delayed Start function. When starting the heat pump, the pool water pump will start to run for 3 minutes, then after another 30 seconds, the heat pump fan motor and compressor will start to run.
6. Check for any abnormal noises from the heat pump.
7. Check the air that is coming out of the heat pump fan, this air temperature should be 5°C-10°C cooler than the ambient air temperature.
8. Test the Flow Switch is working correctly. With the heat pump still running, turn the pool water pump off. If the Flow Switch is working, the heat pump should turn off automatically and the heat pump touchpad will display an error code E3 (no water protection). Turn the pool water pump back on after testing the Flow Switch.
9. It is time to adjust the 3-Way Valve and calibrate the flow rate though the heat pump. Fully close the 3-Way Valve and turn the heat pump to the maximum temperature.
10. Wait 3-4 minutes for the heat pump to run.
11. Slowly open the 3-Way Valve to increase the temperature differential between the inlet and outlet. Closing the 3-Way Valve will decrease the temperature differential.
12. While you are slowly opening the 3-Way Valve, visually check the Flow Check Valve's flap, and open the 3-Way Valve until the flap is slightly open (e.g. approximately 10°–15° angle). Adjust the 3-Way Valve until optimum differential of 2°C-3°C is achieved.
13. The 3-Way Valve is set up correctly when the temperature difference between the inlet and outlet is 2°C-3°C. Once this has been achieved, lock the position of the 3-Way Valve if possible.
14. The initial startup is complete. Choose your desired speed and temperature settings, and allow the heat pump to run 24 hours per day until the desired pool temperature is reached. This can take several days from a cold start.











SECTION 7: OPERATING INSTRUCTIONS

7.1: IMPORTANT OPERATING INFORMATION

- For the heat pump's ideal operating performance, the ideal ambient air temperature is 15°C-25°C.
- In case of power failure during the operation of the heat pump, the heat pump will automatically restart when the power is restored.
- Turn off the power during thunderstorms and severe weather.
- Do not use or store combustible gas or liquid such as thinners, paint or fuel near the heat pump.
- Always keep the heat pump in the upright position.
- The heat pump is designed for heating swimming pools; do not use it for any other purpose.
- The surroundings of the heat pump must be kept clear to avoid restricting ventilation.
- The heat pump must be kept away from any source of fire.
- Do not put anything into the inlet or outlet, and do not remove the fan cover.
- If any abnormal circumstances occur e.g. abnormal noises, smells, smoke and leakage of electricity, switch off the main power immediately and contact your authorised dealer.
- Do not try to repair the heat pump yourself or open the casing.
- To extend the life of your heat pump, ensure the pool water pump is on before starting the heat pump, and turn the pool water pump off after the heat pump is turned off.
- It is recommended to use a swimming pool cover to optimise the efficiency of heating your pool.

7.2: HEAT PUMP TOUCHPAD OVERVIEW







Symbol	Designation	Function
	On/Off Button	<ol style="list-style-type: none"> 1. Press once to Power On/Off. 2. Press for 5 seconds to connect to WIFI.
	Mode Button	<p>Press to select mode:</p> <p>Smart Mode: 100% - 20% capacity (default setting) Silence Mode: 80% - 20% capacity</p>
	Heat/Cool/Auto Button	<p>Press to change between:</p> <p>Auto: 12°C – 40°C Heating: 18°C – 40°C Cooling: 12°C – 30°C</p>
	Up / Down Buttons	<ol style="list-style-type: none"> 1. Press individually to set desired water temperature. 2. Press simultaneously to view current set temperature. 3. Press simultaneously for 5 seconds to change between °C and °F.
	Digital Screen	<p>Default display: Inlet water temperature.</p> <p>When Up & Down buttons are pressed together: displays the set temperature.</p>
	WIFI Connection Light	<p>Fast flashing: Searching network for a connection.</p> <p>Slow flashing: Configuration record is being cleared.</p> <p>Always on: WIFI connection successful.</p>
	Smart Mode Light	<p>Always on: Heat pump is running in Smart Mode.</p>
	Silence Mode Light	<p>Always on: Heat pump is running in Silence Mode.</p>
	Heating Mode / Defrost Light	<p>Always on: Heat pump is running in Heat Mode.</p> <p>Flashing: Heat pump is running the Defrost function.</p>
	Cooling Mode Light	<p>Always on: Heat pump is running in Cooling Mode.</p>
	Automatic Cooling & Heating Mode Lights	<p>Always on simultaneously: Heat pump is running in Automatic Heating and Cooling Mode</p>





7.3: TURNING ON THE HEAT PUMP

1. Ensure the 3-Way Valve is set up correctly (refer to Section 6.2).
2. Ensure the main power supply to the heat pump is on.
3. Power on the heat pump by pressing .



7.4: SETTING THE TEMPERATURE

1. To view the current set temperature, press  and  at the same time. The screen will flash to show the current set temperature.
2. Once the screen stops flashing and displays the inlet temperature, press either  or  button to adjust the set temperature.

7.5: SETTING THE HEATING/COOLING MODE



1. Press  to select a mode:
 - Auto (12°C – 40°C): Both  and  lights will always be on.
 - Heating (18°C – 40°C):  light will always be on.
 - Cooling (12°C – 30°C):  light will always be on.

7.6: SETTING THE OPERATING MODE (SMART/SILENCE MODE)



MODE	ADVANTAGES
Smart mode 	<ul style="list-style-type: none"> • Default setting • Heating capacity: 20% - 100% • Intelligent optimisation according to ambient temperature and water temperature • Energy efficient setting • Fast heating
Silence mode 	<ul style="list-style-type: none"> • Heating capacity: 20% - 80% • Use at night • Sound level is 3dB (A) lower than Smart Mode

1. Press the  button to change between the 2 modes:







Smart Mode: Smart mode is the default setting and will be activated when the heat pump is turned on. The  light will be on when the heat pump is set to Smart mode.

Silence Mode: Press  button again to enter Silence mode. The  light will be on when the heat pump is set to Silence mode.

7.7: CHANGING TEMPERATURE BETWEEN °C AND °F

1. Press  and  simultaneously for 5 seconds to switch between °C and °F.

7.8: DEFROSTING

1. Auto Defrosting: When the heat pump is defrosting,  will flash. Once the defrosting function has finished,  will stop flashing and the heat pump will return to the previously set operating mode.
2. Compulsory Defrosting: When the heat pump is heating and the compressor is working continuously for 10 minutes, press  and  simultaneously for 5 seconds to start compulsory defrosting. When the heat pump is defrosting,  will flash. Once the defrosting function has finished,  will stop flashing.

NOTE: Compulsory defrosting intervals should be more than 30 minutes and the compressor should run for more than 10 minutes.

SECTION 8: WIFI SETUP

8.1: APP DOWNLOAD AND ACCOUNT REGISTRATION

1. Ensure your mobile device is connected to WIFI. On your mobile device, download the “Inverter life” app in the Apple iOS App Store or the Google Play Store.
2. Create an account in the Inverter Life app. Ensure you allow the app to access devices on your local network, and access Notifications, Bluetooth and WIFI.

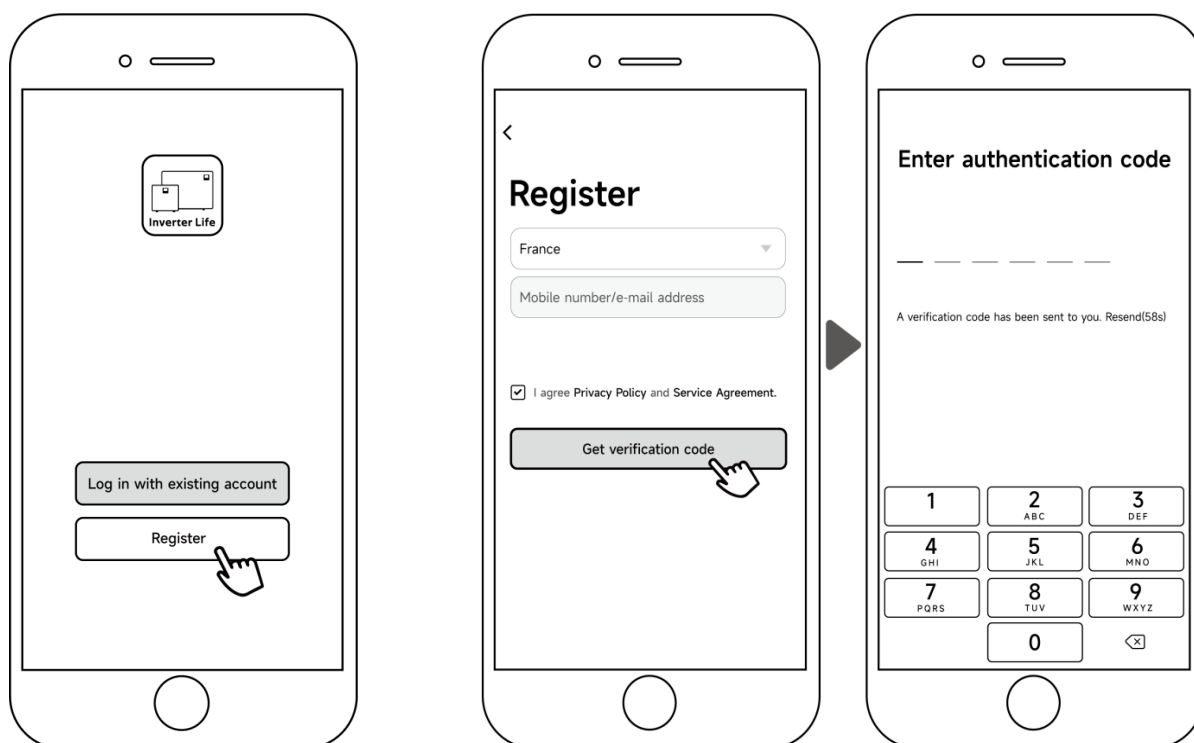
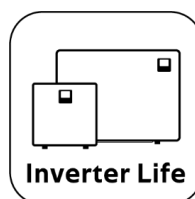

8.2: PAIRING YOUR DEVICE WITH THE HEAT PUMP VIA AUTO-DISCOVERY/BLUETOOTH

1. To begin connecting your heat pump with the app, press  on the heat pump for 5 seconds.  will flash to indicate it has entered pairing mode.
2. Tap on the “add device” button in the Inverter Life app (please allow Location Services). The app will automatically search for available devices. Follow the below steps to finish pairing.

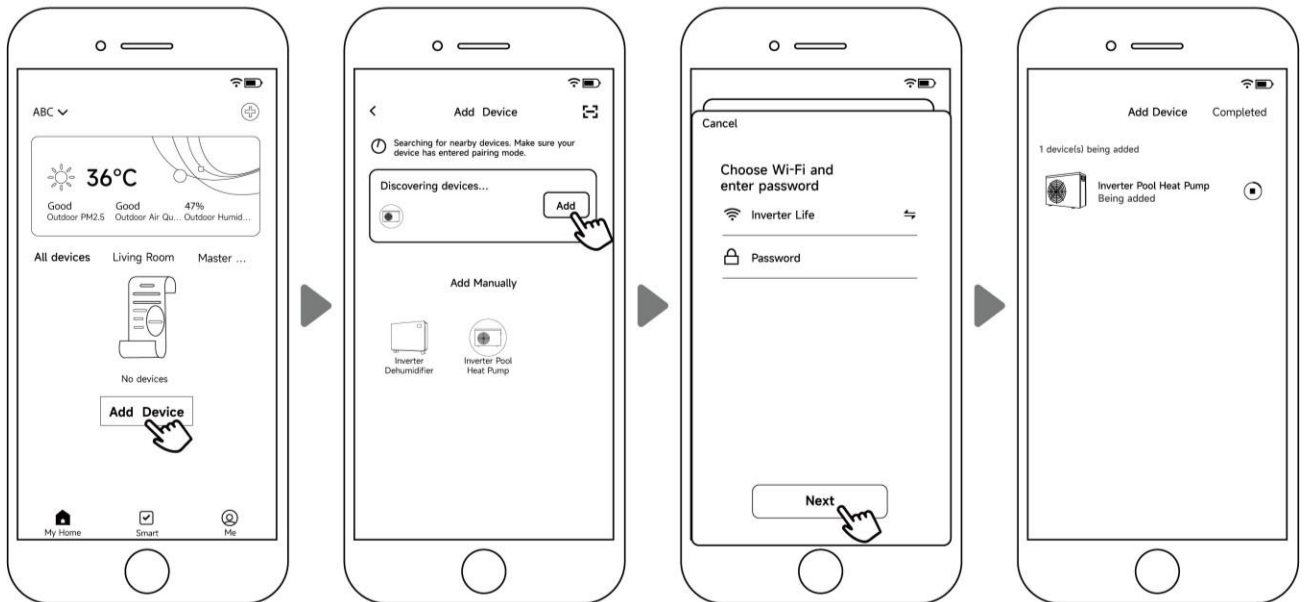

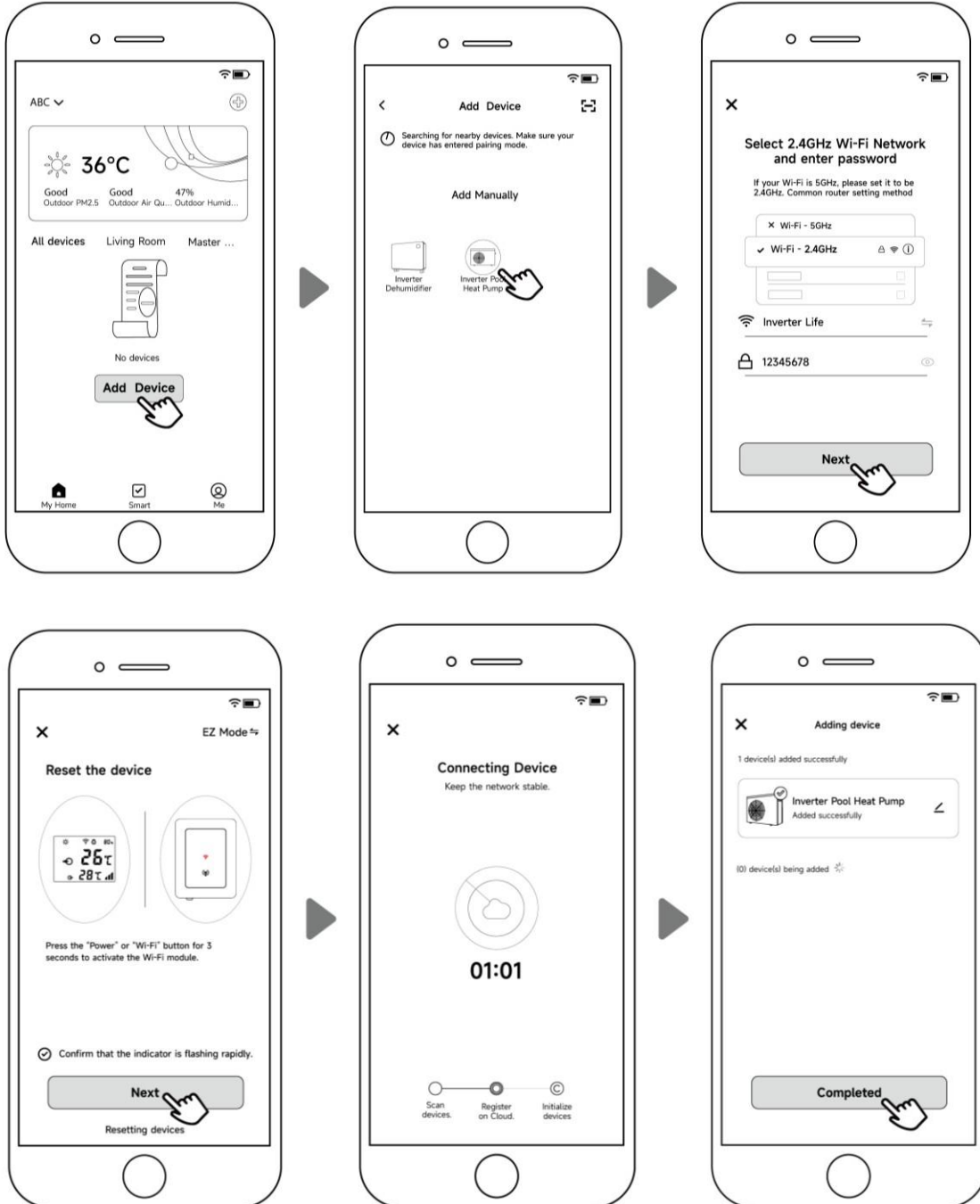

8.3: PAIRING YOUR DEVICE WITH THE HEAT PUMP VIA MANUALLY ADDING

1. To begin connecting your heat pump with the app, press  on the heat pump for 5 seconds.  will flash to indicate it has entered pairing mode.
2. Tap on the “add device” button in the Inverter Life app (please allow Location Services). Add the device manually by following the below steps.



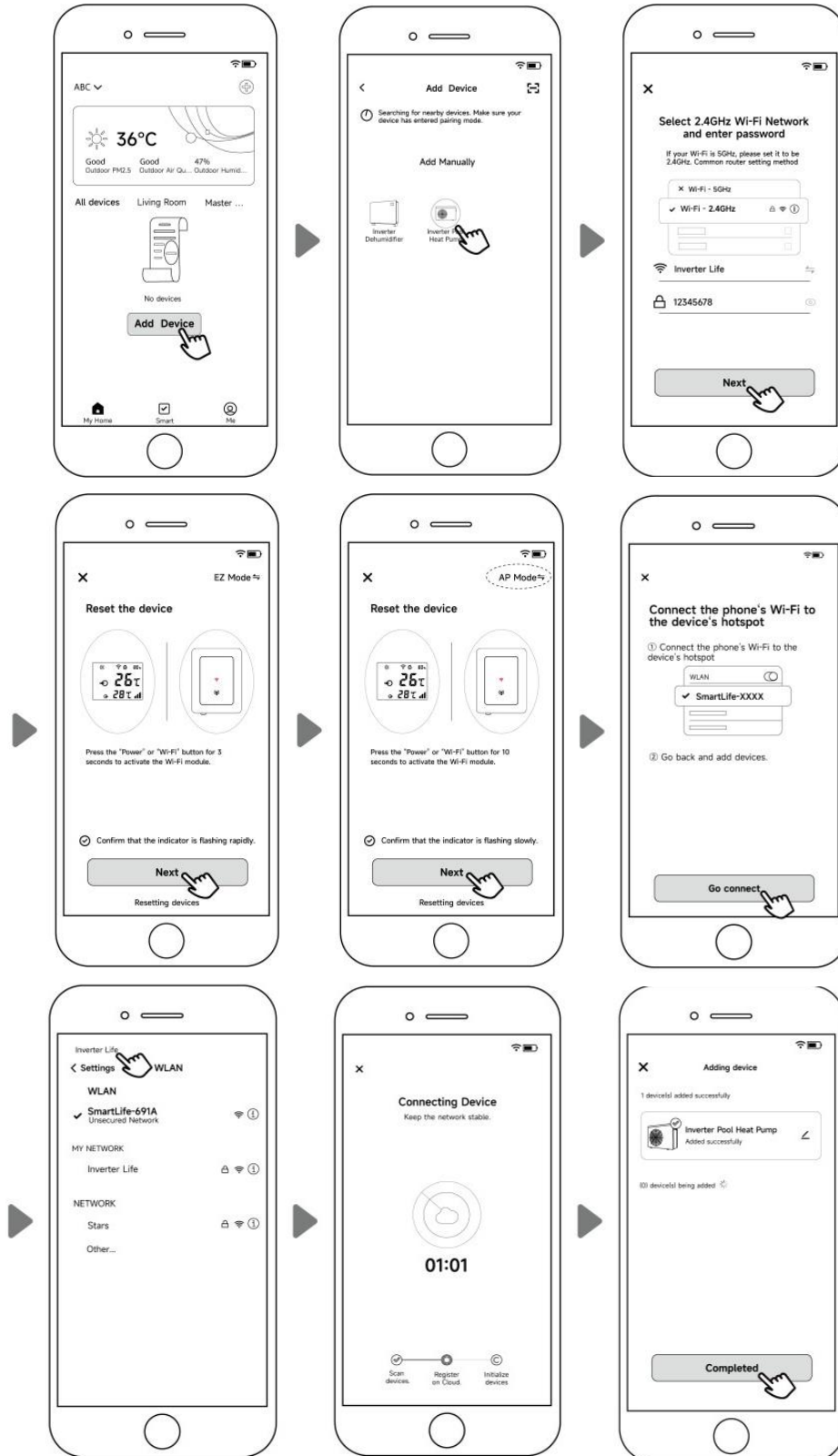

8.4: PAIRING YOUR DEVICE WITH THE HEAT PUMP VIA AP MODE

- To begin connecting your heat pump with the app, press  on the heat pump for 5 seconds.  will flash to indicate it has entered pairing mode.
- Tap on the “add device” button in the Inverter Life app (please allow Location Services). Add the device via AP Mode by following the below steps.



8.5: RE-PAIRING YOUR DEVICE

You may experience a pairing failure if your WIFI password changes or your network configuration changes. To re-pair your mobile device to your heat pump, follow these steps.

1. Ensure your network name and password are correct.
2. Ensure your router, mobile phone and device are as close as possible.
3. Press  on the heat pump for 10 seconds.  will flash slowly for 60 seconds then  will turn off – this has removed your original pairing. Follow any of the steps in 8.2, 8.3 or 8.4 to re-pair your device.

NOTE: Ensure your router is configured at 2.5GHz.

8.6: APP FEATURES

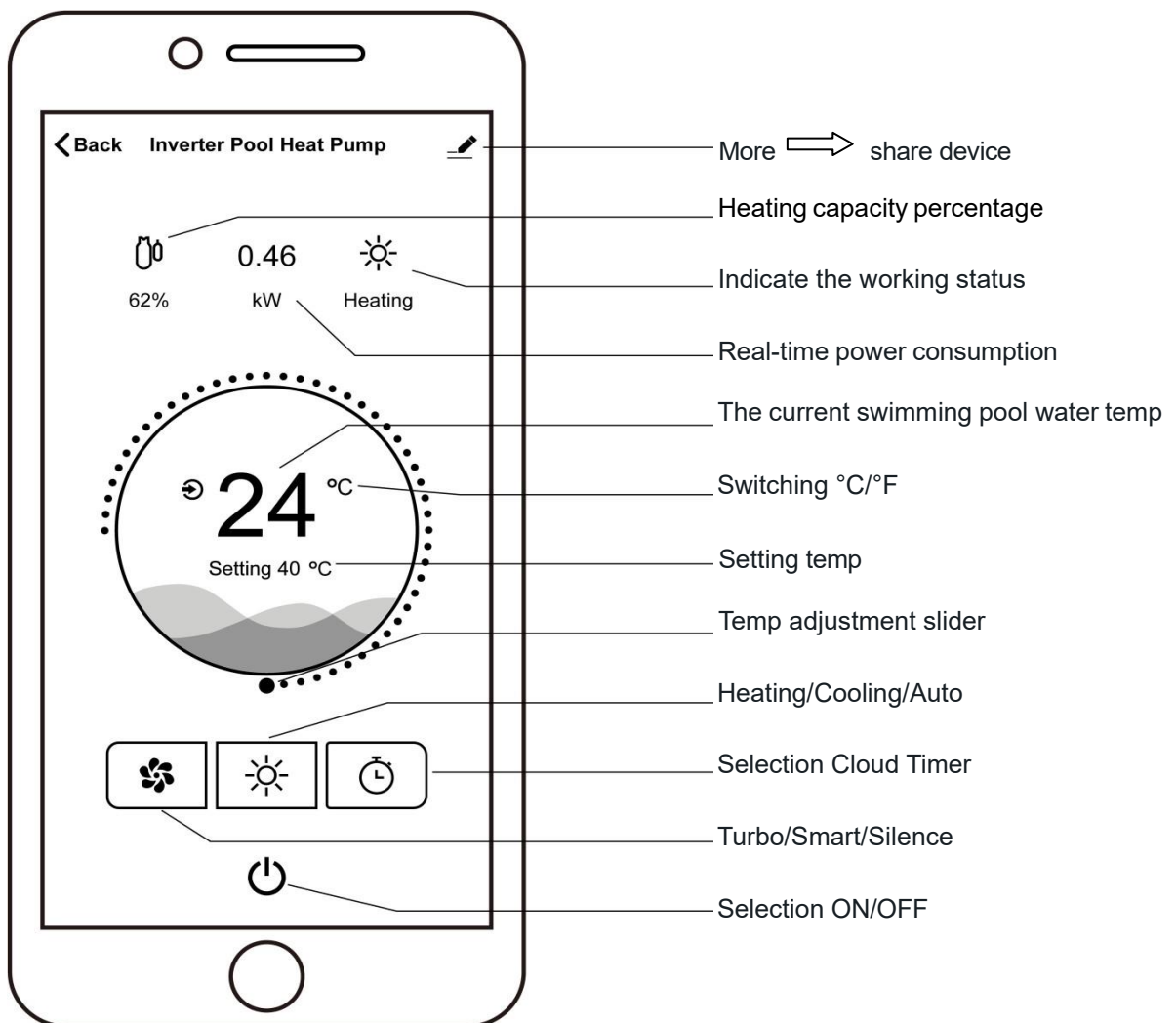

8.7: SHARE DEVICES WITH FAMILY MEMBERS

After you have paired your mobile device with the heat pump, you can share it with other family members.

1. Ensure other family member's device has downloaded/installed the app, and has registered their account in the app (refer to Section 8.1).
2. As the Administrator, tap on More, then tap on Shared Devices. Allow sharing by following the below steps.

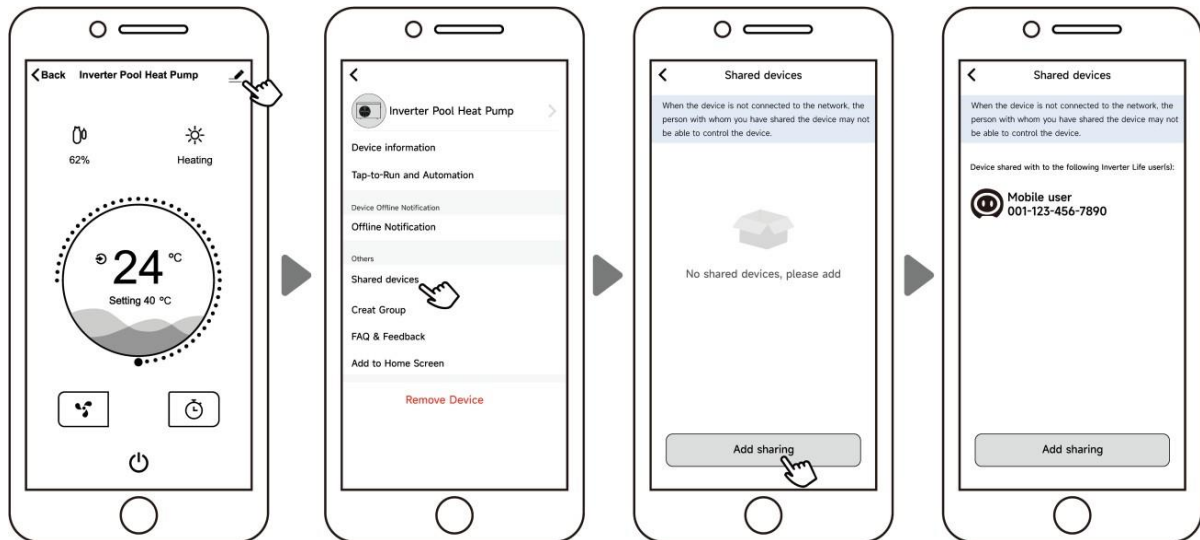

3. Your family member should now be able to see the heat pump in their app.
4. If you'd like more than 1 family member to connect to the same device, you can create a Family in your app.

8.8: CREATE A FAMILY

After you have paired your mobile device with the heat pump, you can share it with other family members.

1. Tap on your profile "Me" in the app, then tap on Home Management.
2. Tap on Add Family. Fill in the details and tap Save.

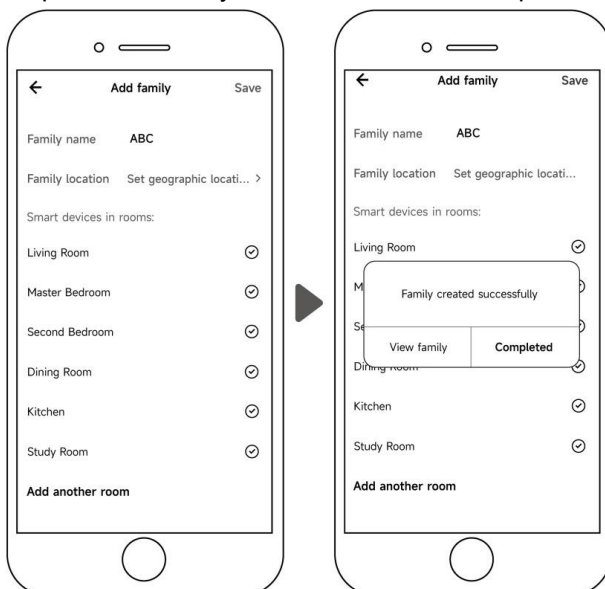

3. Other family members who have the Inverter Life app set up on their mobile device (refer to Section 8.1) can now tap Join a Home to be linked to your Family setup.

SECTION 9: MAINTENANCE

9.1: REGULAR MAINTENANCE

! Regular maintenance can be carried out by the user.

1. Regularly check there are no obstacles blocking the air inlet and outlet of the heat pump.
2. Regularly check all unions, bolts and other visible connections for leaks or signs of wear.
3. If the exterior of the heat pump needs to be cleaned, use only household detergent and water.

9.2: ANNUAL MAINTENANCE – QUALIFIED TECHNICIAN ONLY

! Annual maintenance must be carried out by a qualified professional technician.

1. Turn off the main power supply of the heat pump before cleaning, examination and repairing. Do not touch the electronic components until the LED indication lights on the PC board turn off.

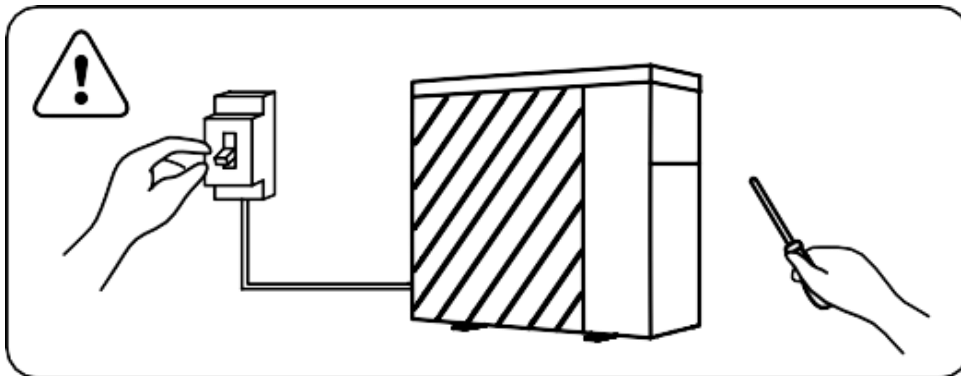

2. Clean the evaporator with household detergents or clean water. NEVER use gasoline, thinners or any similar fuel.
3. Check bolts, cables and connections are in good condition.
4. If any spare parts are required, contact your authorised dealer. Only use genuine spare parts.
5. Only qualified professional technicians must handle/refill gas.

SECTION 10: WINTERISING

! Do not allow water to freeze inside the heat pump, as this may damage the titanium heat exchanger and void your warranty.

! When using the heat pump under 2°C, make sure there is always water flow.

Follow these steps when the heat pump will not be used for an extended period of time e.g. Winter.

1. Turn off the main power supply to the heat pump.

2. Fully close the 3-Way Valve.

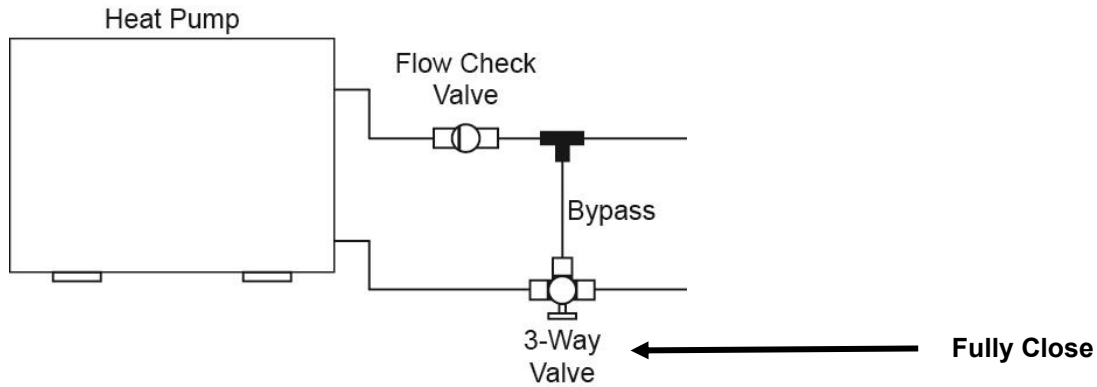

3. Drain the water out of the heat pump by unscrewing the lower union (inlet) and let the water run out.

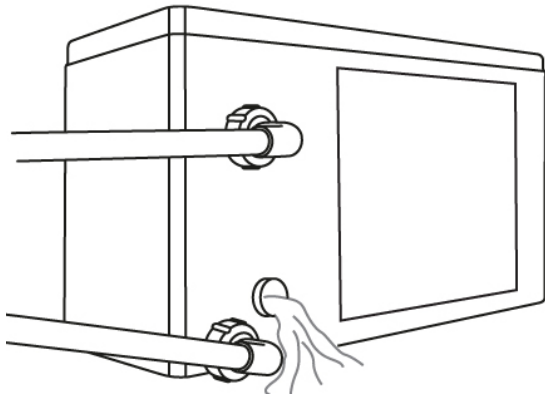

4. Screw the inlet union securely back into place.
5. When you are ready to resume operation of your heat pump, perform all steps in Section 6 to ensure the heat pump is set up correctly.

SECTION 11: TROUBLESHOOTING

ISSUE	POSSIBLE REASON	POSSIBLE SOLUTION
Heat pump doesn't run	No power	Wait until the power recovers
	Power switch is off	Switch on the power
	Fuse burned	Check and change the circuit fuse in your power box
	The breaker is off	Check and turn on the breaker
Fan is running but with insufficient heating	Evaporator blocked	Remove the obstacles
	Air outlet blocked	Remove the obstacles
	3 minutes start delay	Wait patiently
Display normal, but no heating	Set temp. too low	Set proper heating temperature
	3 minutes start delay	Wait patiently
Touchpad not working correctly	Faulty touchpad	Contact your dealer

Note: If the heat pump experiences frequently blown fuses or frequently trips the circuit breaker, power off the heat pump immediately, cut off power supply and contact your installer/dealer.

Note: If the above solutions don't work, please contact your installer with detailed information and your model number. Do not try to repair it yourself.

DISPLAY	DESCRIPTION
E3	No water protection/no water flow
E5	Power supply exceeds operation range
E6	Excessive temp difference between inlet and outlet water (insufficient water flow protection)
Eb	Ambient temperature too high or too low protection
Ed	Anti-freezing reminder
E1	High pressure protection
E2	Low pressure protection
E4	Phases lack protection (three phase models only)
E7	Water outlet temp too high or too low protection
E8	High exhaust temp protection
EA	Evaporator overheat protection (only at cooling mode)
P0	Controller communication failure
P1	Water inlet temp sensor failure
P2	Water outlet temp sensor failure
P3	Gas exhaust temp sensor failure
P4	Heating (Evaporator) coil pipe temp sensor failure
P5	Gas return temp sensor failure
P6	Cooling (heat exchanger) coil pipe temp sensor failure
P7	Ambient temp sensor failure
P8	Cooling plate sensor failure
P9	Current sensor failure
PA	Restart memory failure
F1	Compressor drive module failure
F2	PFC module failure
F3	Compressor start failure
F4	Compressor running failure
F5	Inverter board over current protection
F6	Inverter board overheat protection
F7	Current protection
F8	Cooling plate overheat protection
F9	Fan motor failure
Fb	Capacitor no charging protection
FA	PFC module over current protection

SECTION 12: SCHEMATICS

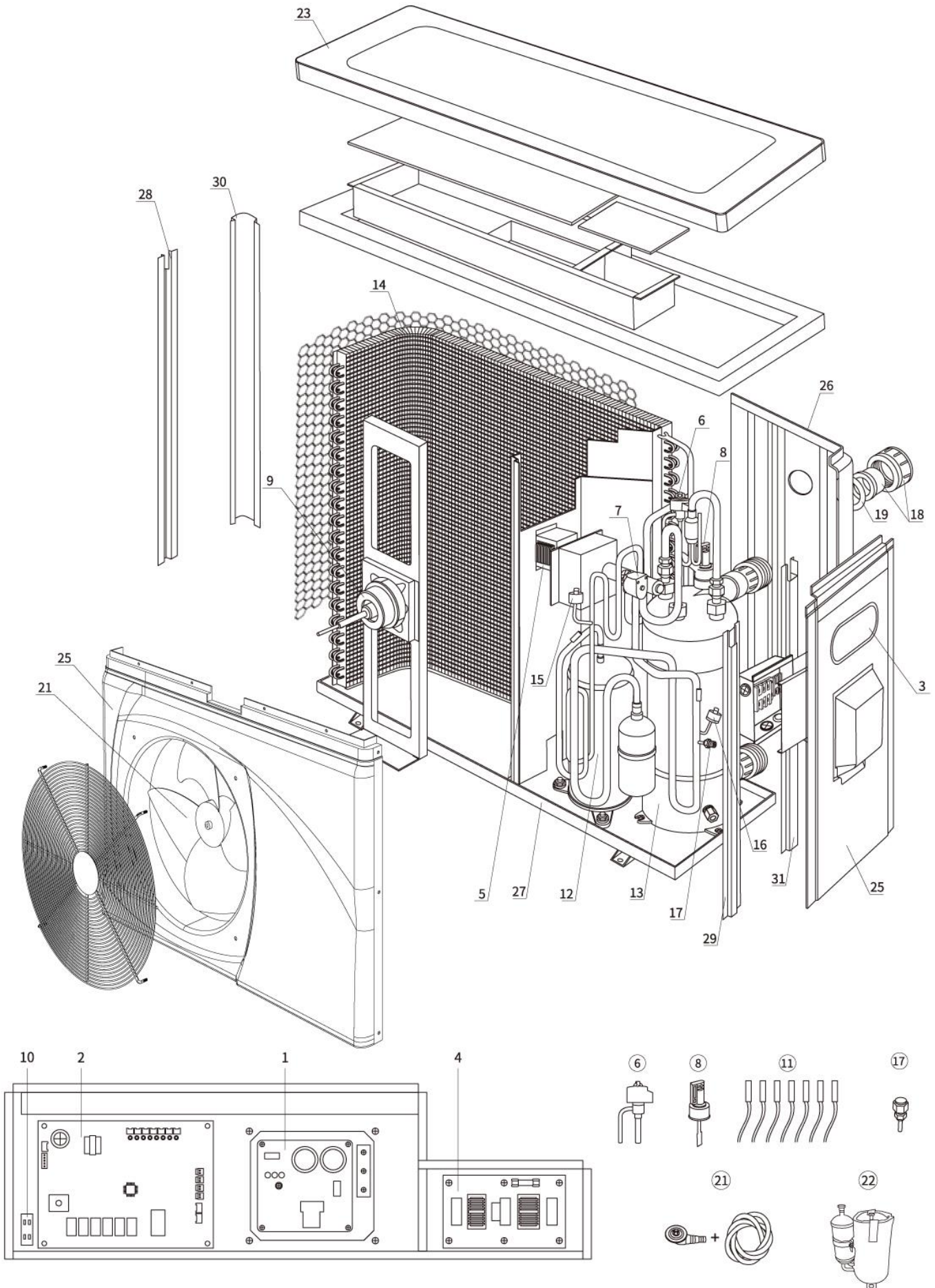

MODELS NHE07, NHE09, NHE13, NHE17, NHE21

Ref #	Stock Code	DESCRIPTION
1	NHEP040	Inverter board for NHE07 & NHE09
1	NHEP041	Inverter board for NHE13
1	NHEP042	Inverter board for NHE17
1	NHEP043	Inverter board for NHE21
2	NHEP060	PC board for NHE07
2	NHEP061	PC board for NHE09
2	NHEP062	PC board for NHE13
2	NHEP063	PC board for NHE17
2	NHEP064	PC board for NHE21
3	NHEP055	Oval LED (Heat & Cool) for all NHE models
4	NHEP070	Power filter plate for NHE07 & NHE09
4	<i>TBA</i>	Power filter plate for NHE13 & NHE17
4	N/A	Power filter plate for NHE21
5	NHXP340	Reactor for NHE07 & NHE09
5	NHXP341	Reactor for NHE13
5	NHXP342	Reactor for NHE17 & NHE21
6	<i>TBA</i>	Electronic expansion valve for NHE07, NHE09, NHE13 & NHE17
6	NHXP251	Electronic expansion valve for NHE21
7	NHXP210	4-Way Valve for NHE07, NHE09 & NHE13
7	NHXP211	4-Way Valve for NHE17 & NHE21
8	<i>TBA</i>	Water flow switch for all NHE models
9	NHEP020	Fan motor for NHE07
9	NHEP021	Fan motor for NHE09
9	NHEP022	Fan motor for NHE13
9	NHEP023	Fan motor for NHE17 & NHE21
10	NHEP010	Fan motor capacitor for NHE07 & NHE09
10	NHEP011	Fan motor capacitor for NHE13, NHE17 & NHE21
11	NHEP075	Full set of sensors for all NHE models
12	NHEP001	Compressor for NHE07 & NHE09
12	NHEP002	Compressor for NHE13
12	NHEP003	Compressor for NHE17 & NHE21
13	NHEP080	Titanium heat exchanger (Heat & Cool) for NHE07
13	<i>TBA</i>	Titanium heat exchanger (Heat & Cool) for NHE09
13	NHEP081	Titanium heat exchanger (Heat & Cool) for NHE13
13	NHEP082	Titanium heat exchanger (Heat & Cool) for NHE17
13	NHEP083	Titanium heat exchanger (Heat & Cool) for NHE21
14	<i>TBA</i>	Evaporator for NHE07
14	<i>TBA</i>	Evaporator for NHE09
14	<i>TBA</i>	Evaporator for NHE13

14	TBA	Evaporator for NHE17
14	TBA	Evaporator for NHE21
15	NHXP280	High pressure protection switch for all NHE models
16	NHEP035	Low pressure protection switch for all NHE models
17	TBA	Low pressure valve for all NHE models
18	NHXP070	Union (black) for all NHE models
19	NHEP095	Union gasket for all NHE models
20	NHEP030	Fan suits NHE07 & NHE09
20	TBA	Fan suits NHE13
20	TBA	Fan suits NHE17 & NHE21
21	TBA	Drainage kit suits all NHE models
N/A	NHXP270	Foot with Bolt Assembly 4pk
22	TBA	Compressor insulation cap for NHE07 & NHE09
22	TBA	Compressor insulation cap for NHE13
22	TBA	Compressor insulation cap for NHE17 & NHE21
23	TBA	Top cover for NHE07, NHE09 & NHE13
23	TBA	Top cover for NHE17 & NHE21
24	TBA	Front panel for NHE07, NHE09 & NHE13
24	TBA	Front panel for NHE17
24	TBA	Front panel for NHE21
25	TBA	Right panel for NHE07, NHE09, NHE13 & NHE17
25	TBA	Right panel for NHE21
26	TBA	Back panel for NHE07 & NHE09
26	TBA	Back panel for NHE13
26	TBA	Back panel for NHE17
26	TBA	Back panel for NHE21
27	TBA	Bottom board for NHE07
27	TBA	Bottom board for NHE09 & NHE13
27	TBA	Bottom board for NHE17 & NHE21
28	TBA	Front left pole for NHE07, NHE09, NHE13 & NHE17
28	TBA	Front left pole for NHE21
29	TBA	Front right pole for NHE07, NHE09, NHE13 & NHE17
29	TBA	Front right pole for NHE21
30	TBA	Back left pole for NHE07, NHE09, NHE13 & NHE17
30	TBA	Back left pole for NHE21
31	TBA	Back right pole for NHE07, NHE09, NHE13 & NHE17
31	TBA	Back right pole for NHE21

* Contact Pool Pro for any parts without a listed code.

SECTION 13: WARRANTY & PRODUCT REGISTRATION

Please register your product online at www.poolpro.com.au/product-registration within 30 days from date of purchase, or any warranty claim may be voided.

- The warranty for the Neptune X-Eco Heat Pump (models NHE07, NHE09, NHE13, NHE17 & NHE21) covers manufacturer's defects in materials and workmanship for:

5 years on the heat exchanger
4 years on the compressor
4 years on all other parts
1 year on labour
- This product is not recommended for commercial installations. Commercial installations have a 1 year warranty on all parts (no labour).
- The warranty is only valid for the original purchaser and is non-transferable.
- Adverse operating conditions beyond the control of the manufacturer such as improper voltage, excessive ambient temperature or any condition that adversely affects the performance of the equipment will render this warranty null and void.
- Defective equipment must be returned to the authorised dealer as soon as the purchaser becomes aware of the defect and all transport costs must be prepaid.
- Neither the manufacturer nor the authorised dealer shall be responsible for any goods damaged in transit.
- Any liability of the manufacturer pursuant to the Trade Practices Act 1974, as amended for a breach of a condition or warranty shall be limited to replacing or acquiring the equipment (or part thereof) where the same has been supplied.
- The maximum liability incurred by the manufacturer shall not in any case exceed the contract price for the equipment or the product parts or components thereof claimed to be defective. Further, the manufacturer shall not be liable for any loss, damage or delay directly or indirectly caused by any malfunction of or defect of or failure of the equipment other than as expressly provided in this warranty.
- The manufacturer and authorised dealer will not be held liable for damage caused to the pool and surrounding areas.
- Keep your original purchase invoice and serial number in a safe place.

Warranty is void under the following circumstances:

- Incorrect operation of the unit by not following correct instructions.
- Improper maintenance and balancing of pool water.
- Damage caused to the heat pump due to misuse or damage caused by any other means than manufacturer defect.
- If the heat pump is repaired or serviced by an unauthorised dealer or serviceman.
- If a fault occurs in the operation of the heat pump by using non-genuine parts/accessories.
- If the heat pump has been misused, neglected, damaged or altered in any way.
- General wear and tear of consumable products.

To submit a warranty request, visit www.poolpro.com.au/serviceclaim